

# YAMAHA YZF-R3 '16-'20

## M O U N T I N G I N S T R U C T I O N S

REF 20130N

TAPA LATERAL IZQUIERDO / LEFT SIDE COVERS



1 Person



1 hour



EASY

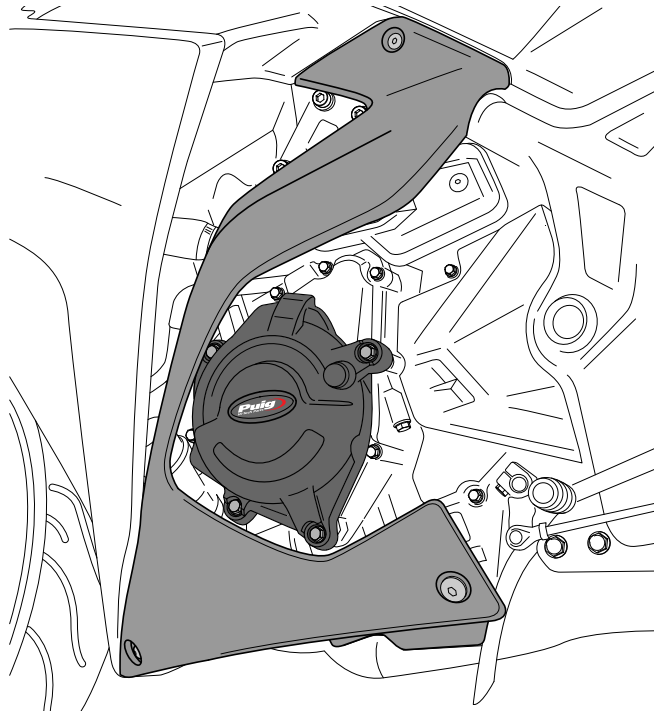

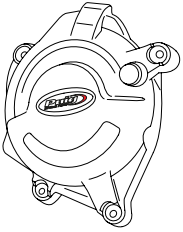
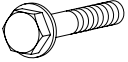
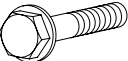
ID.	PIEZA / PART	DESCRIPCIÓN	DESCRIPTION	QTY.	REF.:
1		Tapa izquierda	Left cover	1	CONJUNTO--20130N
2		Tornillo M6x35 DIN6921	DIN6921 M6x35 screw	3	-
3		Tornillo M6x40 DIN6921	DIN6921 M6x40 screw	1	-

**CONSULTAR EN NUESTRA PAGINA WEB LA DISPONIBILIDAD DEL VIDEO DE MONTAJE DE ESTA REFERENCIA.  
CONSULT OUR WEBSITE THE VIDEO MOUNT AVAILABILITY OF THIS REFERENCE.**



# YAMAHA YZF-R3 '16-'20

REF 20130N

INSTRUCCIONES DE MONTAJE - MOUNTING INSTRUCTIONS - MONTAGEANLEITUNG

**1**

DESMTAR EL CARENADO /  
REMOVE THE COVER

DISASSEMBLY  
DESMONTAJE

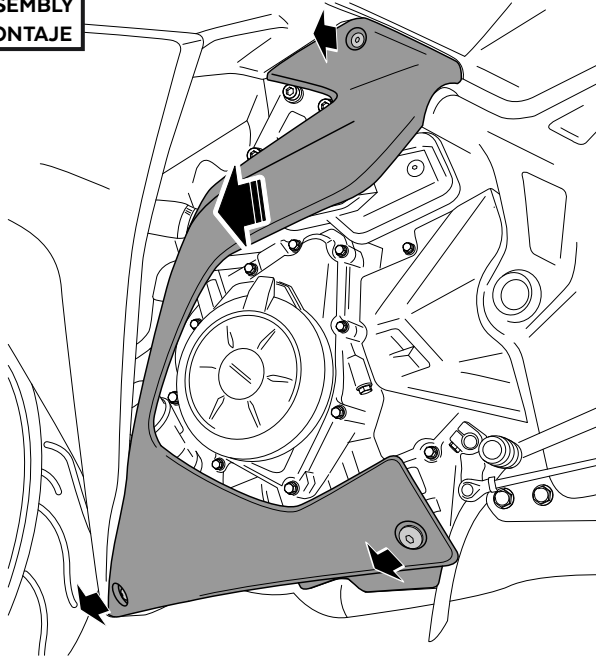

**A** Tornillería original  
Original screws

**2**

DISASSEMBLY  
DESMONTAJE

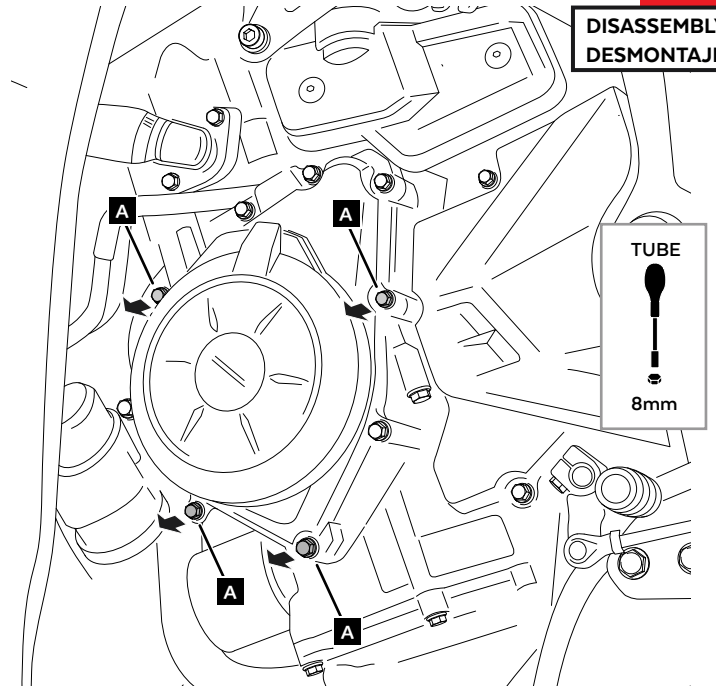

**3**

ASSEMBLY  
MONTAJE

TUBE  
8mm

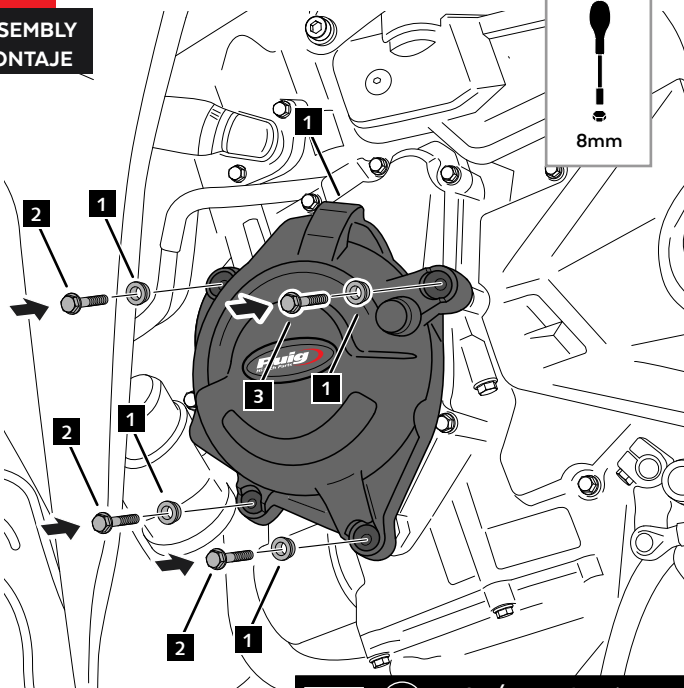

**2-3** 10 N/m - Par de apriete  
7,82 lbf/ft - Tightening torque

MONTAR EL CARENADO /  
ASSEMBLE THE COVER

**4**

ASSEMBLY  
MONTAJE

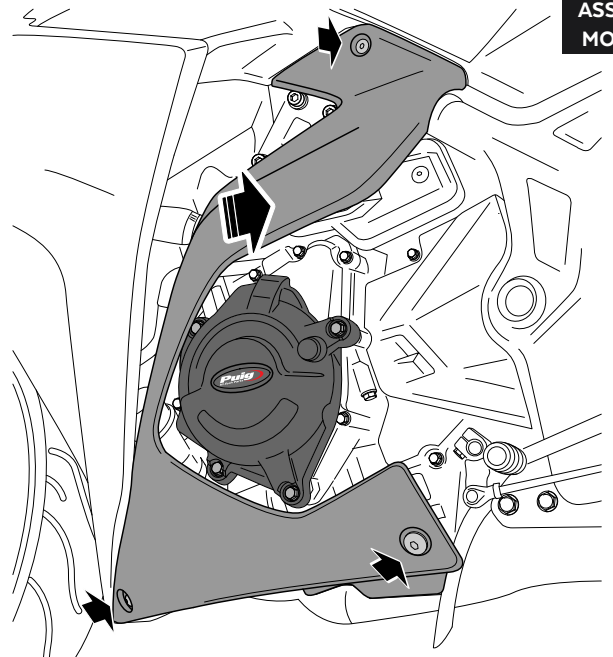

# YAMAHA YZF-R3 '16-'20

## M O U N T I N G I N S T R U C T I O N S

REF 20130N

TAPA LATERAL DERECHO / RIGHT SIDE COVERS



1 Person



1 hour



EASY

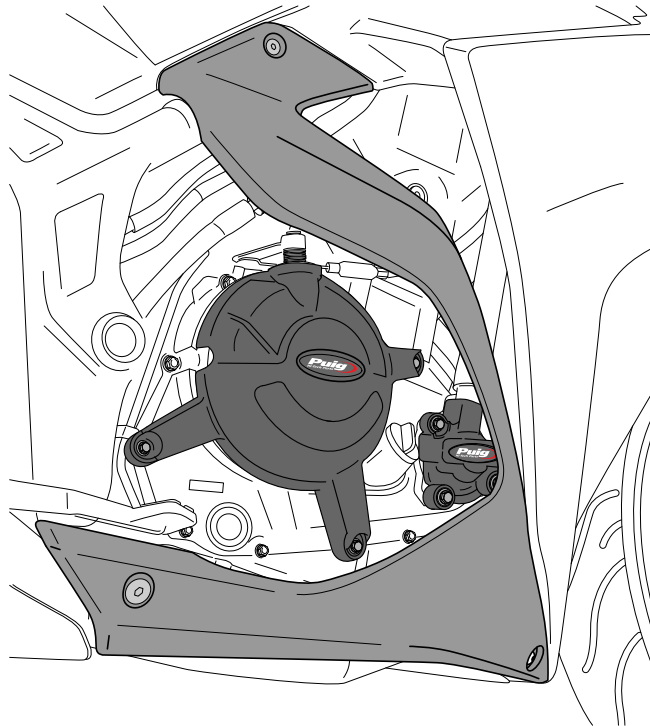

ID.	PIEZA / PART	DESCRIPCIÓN	DESCRIPTION	QTY.	REF.:
1		Tapa derecha 1	Right cover 1	1	CONJUNTO--20130N
2		Tapa derecha 2	Right cover 2	1	CONJUNTO--20130N
3		Tornillo M6x30 DIN6921	M6x30 DIN6921 screw	3	-
4		Tornillo M6x35 DIN6921	M6x35 DIN6921 screw	4	-
5		Arandela M6	M6 washer	1	-

# YAMAHA YZF-R3 '16-'20

REF 20130N

INSTRUCCIONES DE MONTAJE - MOUNTING INSTRUCTIONS - MONTAGEANLEITUNG

1

DESMTAR EL CARENADO /  
REMOVE THE COVER

DISASSEMBLY  
DESMONTAJE

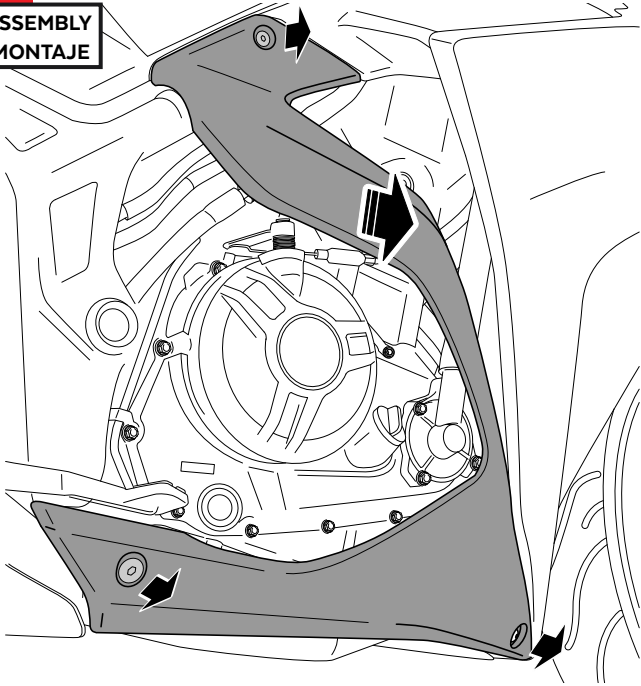

2

A Tornillería original  
Original screws

DISASSEMBLY  
DESMONTAJE

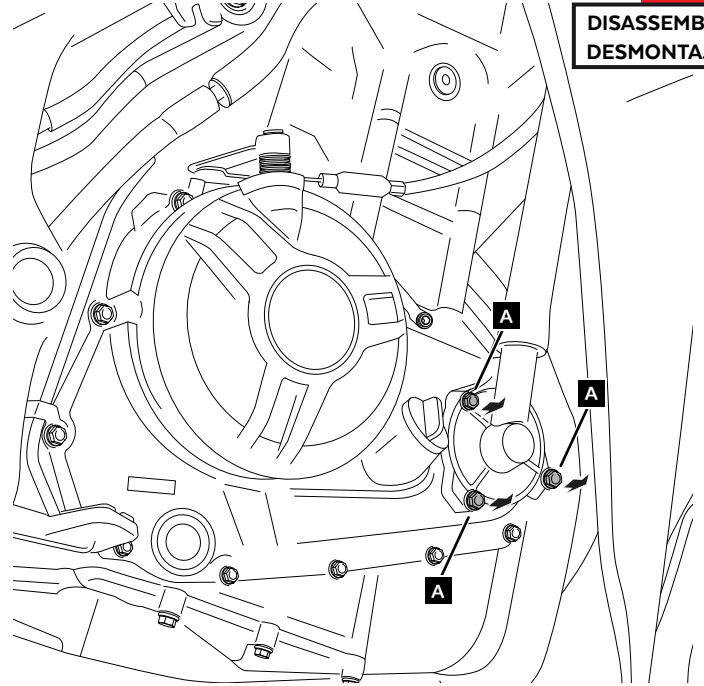

3

ASSEMBLY  
MONTAJE

3 10 N/m - Par de apriete  
7,82 lbf/ft - Tightening torque

TUBE

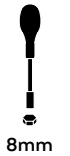

8mm

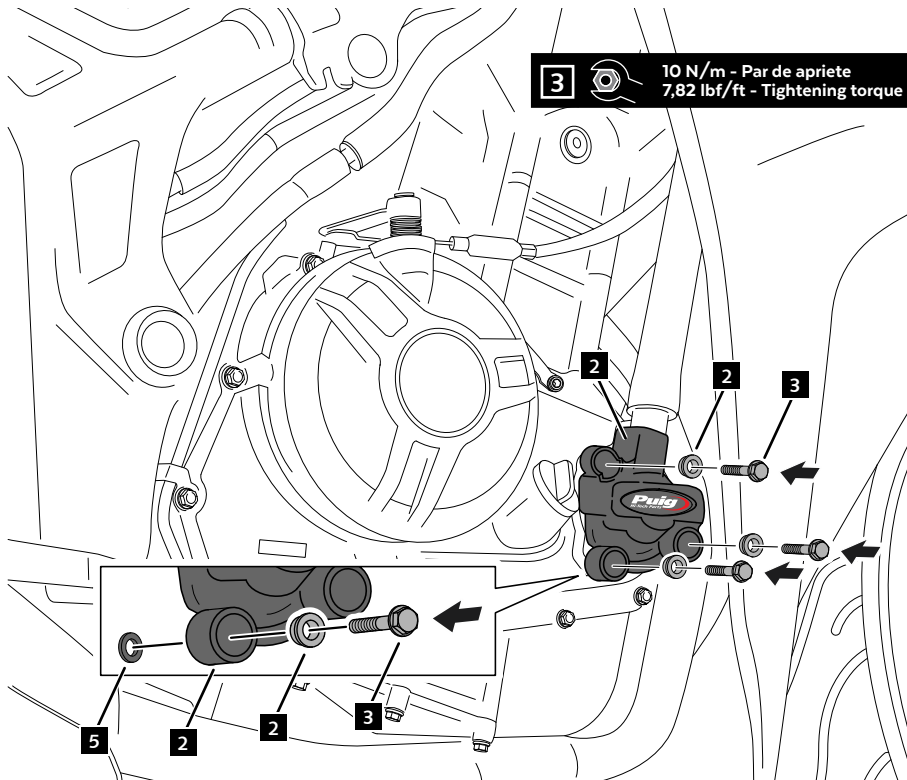

# YAMAHA YZF-R3 '16-'20

REF 20130N

INSTRUCCIONES DE MONTAJE - MOUNTING INSTRUCTIONS - MONTAGEANLEITUNG

**4**

DISASSEMBLY  
DESMONTAJE

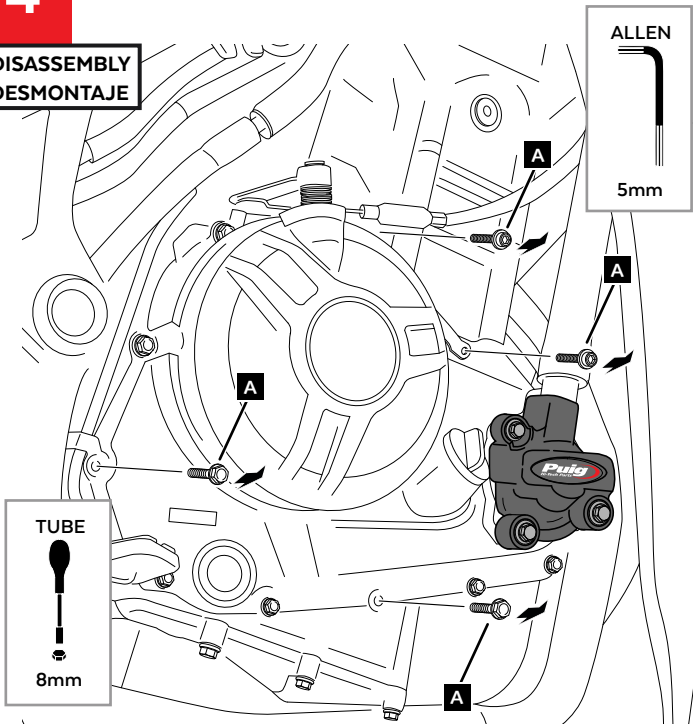

**5**

ASSEMBLY  
MONTAJE

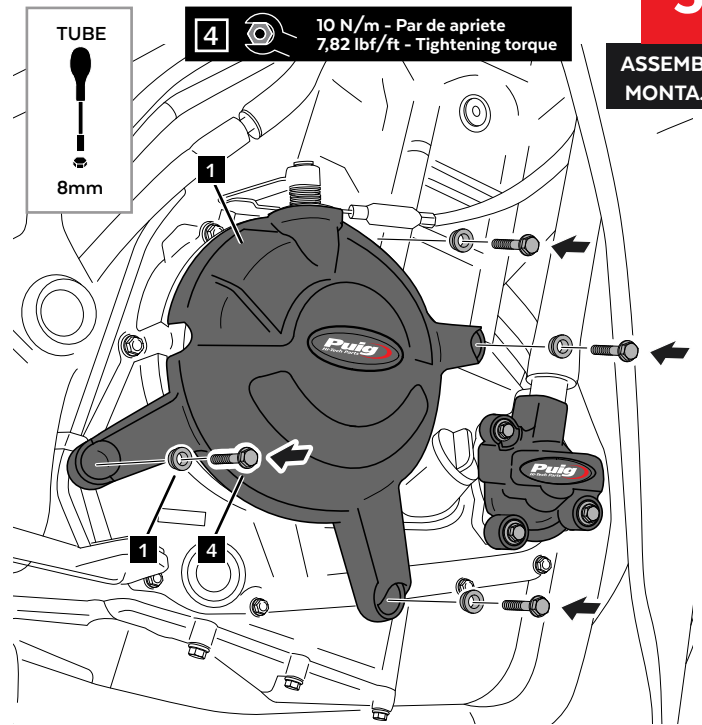

**6**

ASSEMBLY  
MONTAJE

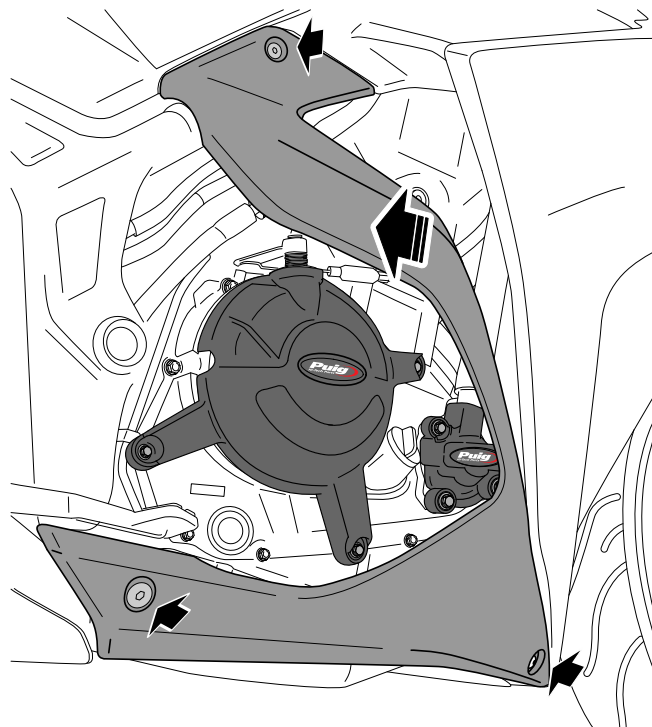

MONTAR EL CARENADO /  
ASSEMBLE THE COVER